

niccons

HVAC MANUFACTURING

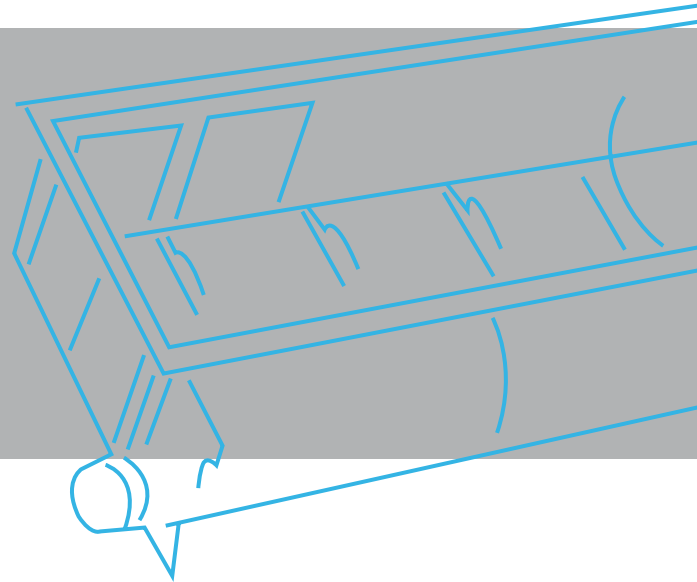

1.2

Scatole predisposizione ***Embedded boxes***

SCATOLE PREDISPOSIZIONE AD INCASSO - EMBEDDED BOXES

CLIMABOX CLIMABOX



Riduzione orizzontale - Reduction

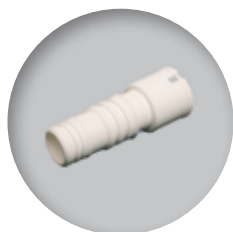

Fix Dima - Template Fastener

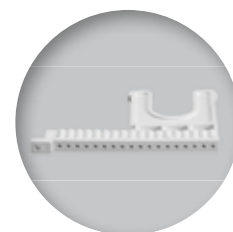

Scatola da posizionare all'interno del muro dietro allo split, viene utilizzata nelle nuove costruzioni, o nelle ristrutturazioni, in cui è previsto l'impianto di condizionamento con il passaggio dei tubi sotto traccia (non viene utilizzata la canalina).

Caratteristiche:

- Realizzata in Polistirene alto-antiurto di prima scelta
- Dotata di due uscite laterali Ø20 mm presfondabili e di riduzione per tubo Ø16-18 mm
- La vaschetta raccogli condensa ha un'ampia capienza e permette un facile posizionamento del tubo scarico condensa
- Fornita con fascia isolante per evitare la formazione della condensa di fronte a temperature critiche di esercizio
- Completa di "fix dima" da ancorare al fondo della predisposizione ed utile per fissare la dima del condizionatore
- I piedini di appoggio facilitano la messa in opera della scatola
- Confezionata singolarmente in astuccio con istruzioni per il montaggio

Embedded box to be installed inside the wall behind the conditioner. It is used in new buildings or in restructuring where the air-conditioning system is designed with pipes recessed inside the wall and without external ducting.

Features:

- Made of high-quality and high shock resistance Polystyrene
- Two side outputs Ø20 mm and a drain hose adapter for size Ø16-18 mm
- The high capacity of the tray avoids overflow and allows an easy positioning of the drain hose
- Provided with insulation band to avoid condensation in case of critical temperatures
- Provided with "fix dima" to be anchored to the bottom of the box in order to fix the template of the conditioner
- The support pins ensures a perfect installation and assembly
- Singularly packed in a box with clear installing instructions



9899-001-01



430x130x65 mm



24 pz



384 pz



12,54



CLIMABOX CON SIFONE
CLIMABOX WITH SIPHON



La scatola predisposizione Climabox viene ora fornita completa di un innovativo sifone, studiato per evitare il riflusso di cattivi odori.

Dotazione: due uscite laterali presfondabili Ø 20 mm

Fix Dima

Riduzione per tubo Ø 16-18 mm

Fascia isolante

Sifone da posizionare come mostrato nel disegno

Climabox is now supplied with a complete and innovative siphon, designed to prevent back-flow or bad smells.

Equipment: two side outlets Ø 20 mm

Fix template

Reduction for hose Ø 16-18 mm

Insulation tape

Siphon (to be positioned as shown in the drawing)



9899-001-11



430x130x65 mm



24 pz



384 pz



24,12

SCATOLE PREDISPOSIZIONE AD INCASSO - EMBEDDED BOXES

CLIMABOX GOLD GOLD CLIMABOX



Alette di fissaggio
Fixing wings

Riduzione orizzontale
Horizontal reduction

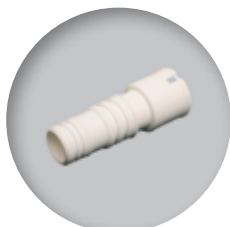

Riduzione verticale
Vertical reduction



Fix Dima
Template Fastener

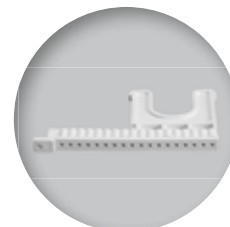

Le 4 ali che la compongono ne rendono molto più veloce l'installazione, la quale avviene tramite collanti a presa rapida. Non è più necessario utilizzare la malta per fissarla a muro.

Thanks to the 4 wings the product is unique in his field the installation is easier and faster using the quick-setting glue. You no longer need to use concrete to install it on the wall.



9899-011-01

430x130x65 mm

24 pz

384 pz

13,06

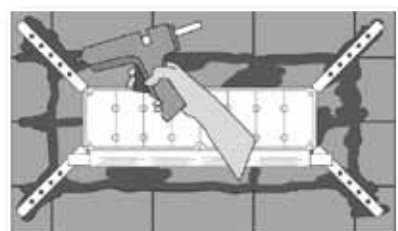

Esempio di installazione
Installation example

CLIMABOX GOLD CON SIFONE GOLD CLIMABOX WITH SIPHON



Alette di fissaggio
Fixing wings

Riduzione orizzontale
Horizontal reduction

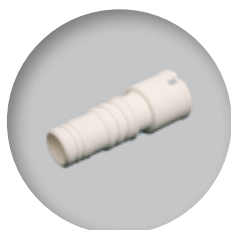

Riduzione verticale
Vertical reduction



Fix Dima
Template Fastener

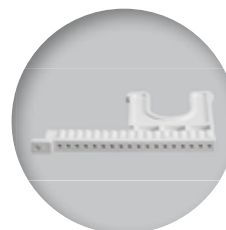

La scatola predisposizione Climabox Gold viene ora fornita completa di un innovativo sifone, studiato per evitare il riflusso di cattivi odori.

Dotazione: due uscite laterali prefondabili Ø 20 mm Fix Dima, riduzione per tubo Ø 16-18 mm, riduzione per uscita verticale, fascia isolante, alette di fissaggio e sifone da posizionare come mostrato nel disegno.

Climabox Gold comes now complete with an innovative siphon, designed to prevent back-flow and bad smells.

Equipment: two side outlets Ø20 mm, fixing template, reduction for Ø 16-18 mm, output vertical reduction vertical, insulation tape, fixing wings and siphon to be positioned as shown in the drawing.



9899-011-11

430x130x65 mm

24 pz

384 pz

26,71

SUN CLIMABOX SUN CLIMABOX



Riduzione orizzontale
Horizontal reduction

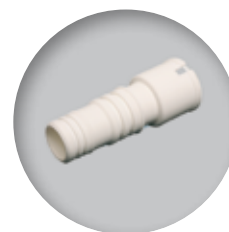

Costruita con materiale riciclato in modo da salvaguardare l'ambiente, pur mantenendo l'alta qualità da sempre caratteristica della nostra produzione.

Rispetto alla Climabox:

- Non è dotata di "fix dima"
- Non viene fornita con la fascia isolante

Made of recycled material in accordance with the new environmental sensibility. Niccons still ensures the high quality of the product and material, usual of our productions.

Compared to Climabox:

- without "Template fastener"
- without insulating band



9899-010-0115

430x130x65 mm

24 pz

384 pz

9,10

UNIVERSAL
UNIVERSAL



Riduzione orizzontale
Horizontal reduction

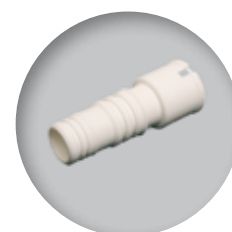

Caratterizzata da una uscita laterale Ø20 mm reversibile a scarico laterale, completa di riduzione per tubo Ø16-18 mm.

Characterized by a side output Ø20 mm which can be mounted to the right or to the left. Provided with an adapter for drain hose size Ø16-18 mm.



9899-002-01	485x125x60 mm	30 pz	480 pz	10,91
--------------------	---------------	-------	--------	--------------

SCATOLE PREDISPOSIZIONE AD INCASSO - EMBEDDED BOXES

FREEBOX
FREEBOX

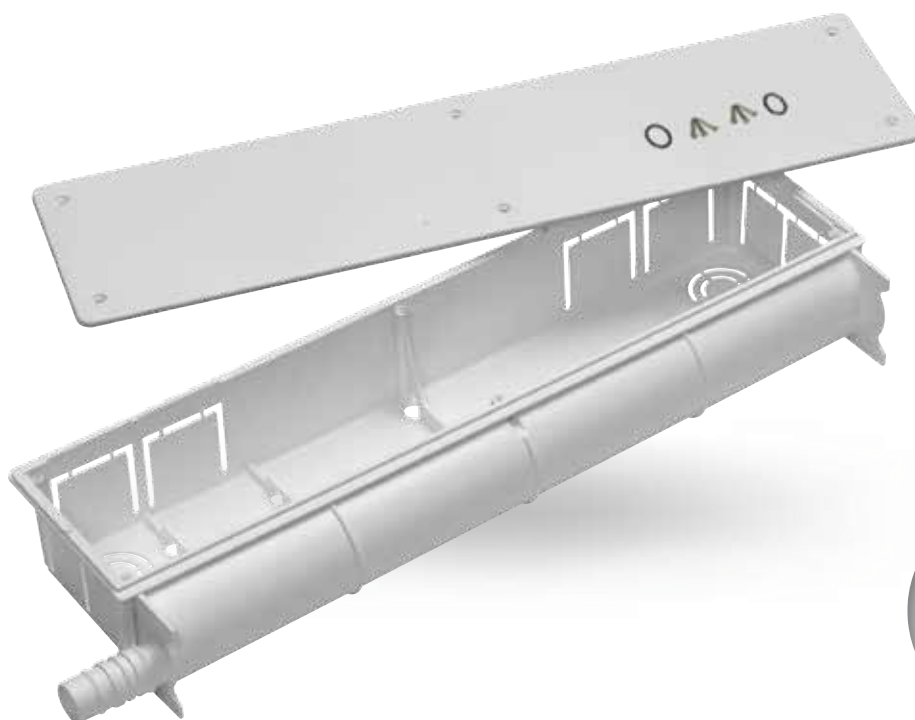



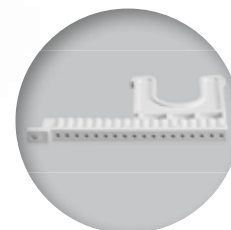

Fix Dima
Template Fastener



Tutte le nostre scatole per predisposizione ad incasso sono fornite con guarnizioni di tenuta e viti per la chiusura del coperchio.

Caratterizzata da una uscita laterale Ø16-20 mm fissa a sinistra, completa di "fix dima", ha dimensioni più compatte per l'utilizzo in pareti sottili quali il cartongesso.

Characterized by a left-mounted fixed side output Ø16-20 mm. Provided with "fix dima". Smaller dimensions enables mounting even in thin walls such as plasterboards.

				
9899-006-01	380x120x55 mm	30 pz	480 pz	7,60
9899-016-01	380x120x55 mm*	30 pz	480 pz	7,60

* Con uscita verticale - With vertical side output



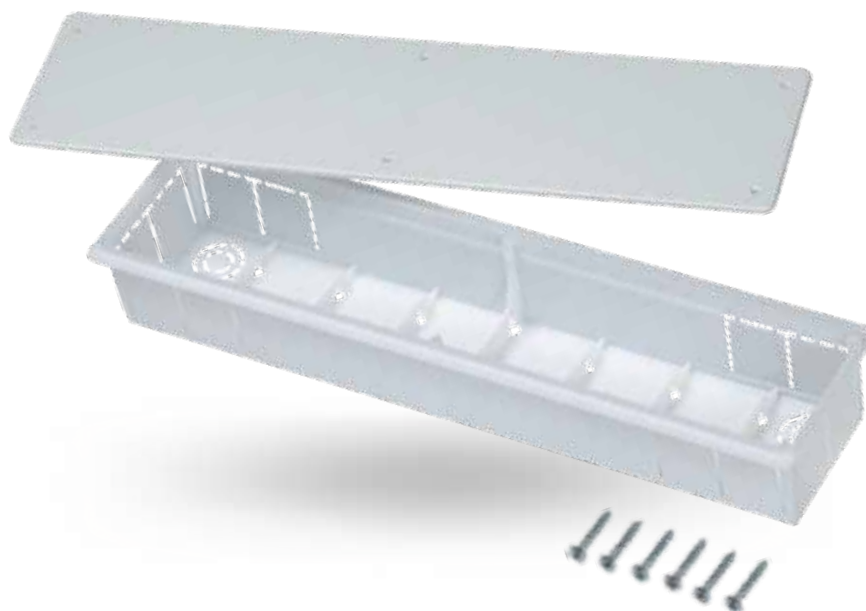

SIMPLE E MINI SIMPLE
SIMPLE AND MINI SIMPLE



Each embedded box is supplied with sealing gaskets and screws for a tight closure of the cover.

Semplice, senza vaschetta raccogli condensa. Può essere installata anche verticalmente e venire eventualmente utilizzata come scatola per esterni.

Simple and without condensation tray. It could be mounted also vertically and even used as an external box.

 CODE				
9899-003-01	430x110x65 mm	30 pz	480 pz	7,47
9899-004-01	430x110x50 mm	35 pz	560 pz	6,87

MULTIBOX MULTIBOX



Senza vaschetta raccogli condensa ma completa di un imbuto con scarico Ø20 mm. Può essere utilizzata orizzontalmente o verticalmente e fungere da scatola per esterni.

Without condensation tray. It comes with a Ø20 mm discharge funnel which could be mounted horizontally and vertically. Suitable for external use.



9899-005-01

430x110x65 mm

30 pz

480 pz

9,45





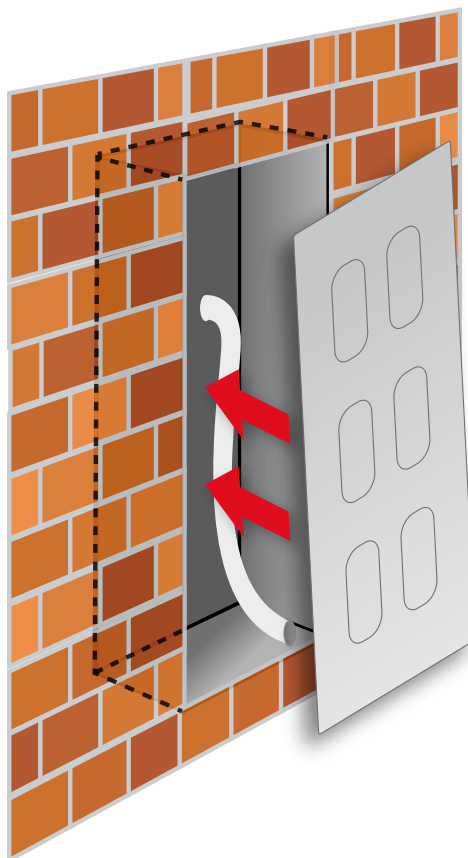

**SCATOLE PREDISPOSIZIONE
PER ESTERNO IN METALLO**
*METAL EMBEDDED BOXES
FOR EXTERNAL UNITS*



Le scatole di predisposizione in metallo per esterno sono molto utili per coprire i tubi in rame e i tubi di scarico condensa lasciati a vista, eliminando il problema antiestetico dalle unità abitative. Sono dotate di 10 ingressi e 6 uscite per le linee frigorifere.

Metal embedded boxes for outside piping, useful to cover visible copper tubes and condensation pipes. Supplied with 10 inputs and 6 outputs for refrigerant lines.

 CODE	 LxHxP		 €
9899-014-7001	100x450x60 mm	2	49,12
9899-015-7001	150x500x80 mm	2	52,36
9899-016-7001	200x600x80 mm	2	64,15



niccons

Niccons Italy S.r.l.

Via dell'Economia, 85 - 36100 Vicenza

Tel. 0444 289383 - Fax 0444 289563

info@niccons.com

www.niccons.com